

FEATURES

1. **Sealed construction** - internal actuator o-ring and epoxy terminal seal standard
2. **IP67 protection Degree**
3. **Surface mounting (SMT)**

SPECIFICATIONS

CONTACT RATING:R- 0.4 VA max @ 20 V AC or DC
 ELECTRICAL LIFE:30,000 make-and-break cycles at full load
 CONTACT RESISTANCE: 20 mΩ max. initial @2-4 VDC,100 mA
 INSULATION RESISTANCE: 1,000 MΩ min.
 DIELECTRIC STRENGTH: 1,500 V RMS @ sea level.
 DEGREE OF PROTECTION : IP67
 OPERATING TEMPERATURE: -30°C to +85°C

MATERIALS

CASE and BUSHING - glass filled nylon PA6T G30 ,flame retardant heat stabilized (UL94V-0)
 Actuator - Nylon,black standard. Internal o-ring seal standard with all actuator.
 CONTACT AND TERMINAL - Copper alloy , silver or gold plated
 SWITCH SUPPORT - Copper alloy , tin-plated
 TERMINAL SEAL - Epoxy

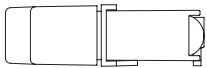
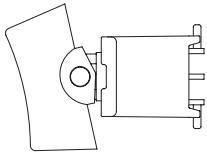

How do you build the switches you need!!

E R - 3 - A 2 - 2 - N R -

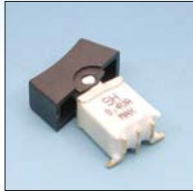
Switches Function		Actuator		Actuator Color		Contact Material		RoHS code
ER-3	SP on-none-on	A1	Std. 7.62	1	white	Q	silver plated	H = RoHS Compliant
ER-3B	SP on-none-(on)	A2	Std. 5.84	2	(std.) black	R	gold plated	
ER-3A	SP on-off-on			3	Red	G	gold over silver	
ER-3H	SP (on)-off-(on)					K	gold / tin	
ER-3I	SP on-off-(on)							
Terminal								
	(none)		std					
	N		backward					
	M		backward					

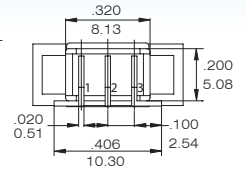
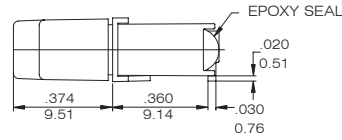
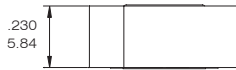
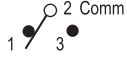

Model No.	Switching position		
ER-3	ON	none	ON
ER-3A	ON	OFF	ON
ER-3B	ON	None	(ON)
ER-3H	(ON)	OFF	(ON)
ER-3I	ON	OFF	(ON)
Term. Comm.	2-3	open	2-1



ER-3-A2-2-R

The M&N terminal type

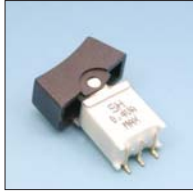

Model No.	Switching position		
ER-3	ON	none	ON
ER-3A	ON	OFF	ON
ER-3B	ON	None	(ON)
ER-3H	(ON)	OFF	(ON)
ER-3I	ON	OFF	(ON)
Term. Comm.	2-3	open	2-1

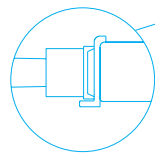
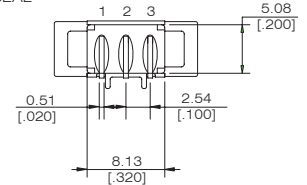
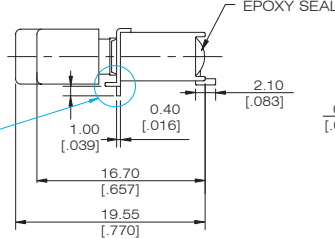
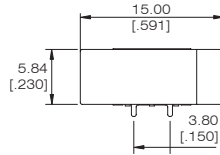
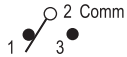

without positioning pins
ER-3-A2-2-NR

ER-3-A2-2-MR

Actuator Option

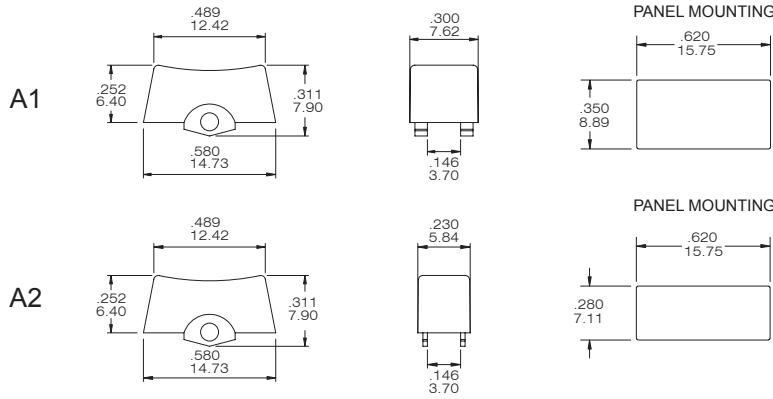

Actuator Color Option

Code	Color
1	white
2	Black(std.)
3	Red

Other colors. custom actuator marking available consult factory.

THE P.C.B MOUNTING

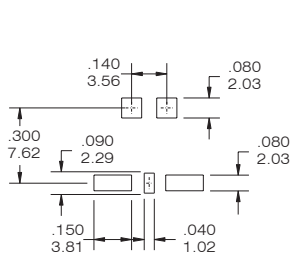

ER-3-A*

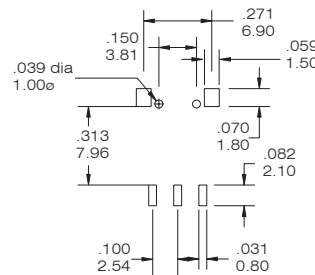

ER-3-A*-M

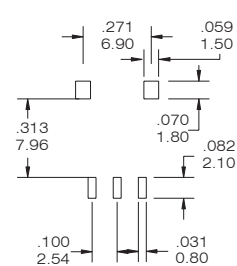

ER-3-A*-N

CONTACT MATERIAL OPTIONS

CODE	CONTACT MATERIAL	TERMINAL MATERIAL	RATING
Q	Silver plated	Silver plated	3 A @ 120V AC or 28 V DC; 1.5 A @ 250 VAC
R	Gold plated over nickel plated	Gold plated over nickel plated	0.4VA MAX @ 20 V AC or DC MAX
G	Gold plated over silver plated	Gold plated over silver plated	0.4 VA MAX @ 20 V AC or DC MAX or 3 A @ 120V AC or 28 V DC; 1.5 A @ 250 VAC
K	Gold plated over nickel plated	Tin over nickel plated	0.4VA MAX @ 20 V AC or DC MAX

INDEX

TOGGLE

ROCKER

SLIDE

PUSH-BUTTON

DIP

TACT